

ΚΑΤΑΛΟΓΟΣ ΤΡΥΠΑΝΙΩΝ ΠΟΛΥΤΡΥΠΑΝΟΥ

20/6/18

DOWELL DRILLS IN HM INTEGRAL - "PLUS" (L - R)

ΤΡΥΠΑΝΙΑ ΠΟΛΥΤΡΥΠΑΝΟΥ (FULL VIDI) ΔΕΞΙ-ΑΡ (ΓΙΑ ΤΣΟΚ 4043... & 4044...)

4042...

- R	- L	D	L	L1				
001	002	2	16	49				
003	004	2,5	27	55				
005	006	3	27	55				
007	008	3,2	27	55				
009	010	3,5	27	55				
011	012	4	27	55				
013	014	5	27	55				

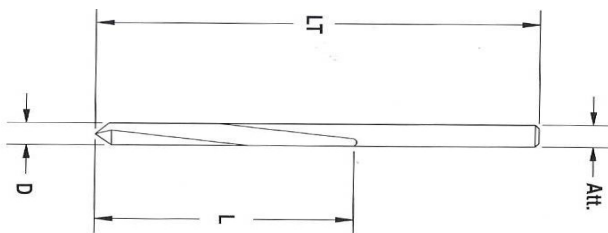

ΓΙΑ ΤΣΟΚ 4043... & 4044...



ΤΡΥΠΑΝΙΑ ΠΟΛΥΤΡΥΠΑΝΟΥ (FULL VIDI) (10X30) ΔΕΞΙ-ΑΡ

4059...

- R	- L	D	L	L1				
001	002	3	57,5	20				
003	004	4	57,5	27				
005	006	5	57,5	27				
007	008	6	57,5	27				
009	010	8	57,5	27				

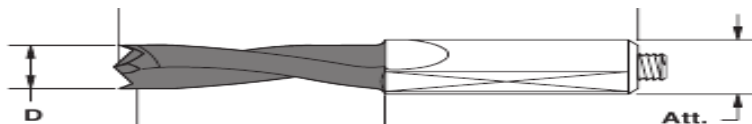

DOWELL DRILLS IN HM INTEGRAL - "PLUS" (L - R)

ΤΡΥΠΑΝΙΑ ΠΟΛΥΤΡΥΠΑΝΟΥ (FULL VIDI) (10X30) ΔΕΞΙ-ΑΡ

4060...

- R	- L	D	L	L1				
001	002	4	70	35				
003	004	5	70	35				
005	006	6	70	35				
007	008	8	70	35				

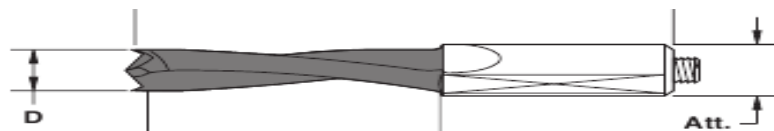

THROUGH HOLE DRILLS IN HM INTEGRAL - "SPECIAL" (L - R)

ΤΡΥΠΑΝΙΑ ΠΟΛΥΤΡ. - ΞΕΤΡΥΠΗΜΑΤΟΣ (FULL VIDI SPECIAL) (10X30) ΔΕΞΙ-ΑΡ
4063



- R	- L	D	L	L1				
001	002	5	70	35				
003	004	6	70	35				
005	006	8	70	35				

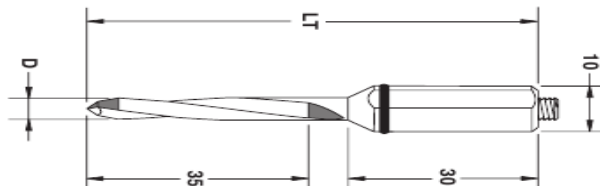

DOWEL DRILLS FOR ANUBA - R

ΤΡΥΠΑΝΙΑ ΠΟΛΥΤΡΥΠΑΝΟΥ " ANUBA " (ΔΕΞΙΑ) (10X35)
4056...



- R	ANUBA	d	D	L	L1			
001	9	3,8	5,0	20	40			
002	11	4,2	5,7	20	45			
003	13	5,2	6,5	15	40			
004	14	5,5	7,0	15	55			
005	16	6	7,7	15	60			
006	18	6,5	8,2	20	70			
007	20	7,2	8,7	20	80			



THROUGH HOLE DRILLINGS (d=10X26) LEFT - RIGHT

ΤΡΥΠΑΝΙΑ ΞΕΤΡΥΠΗΜΑΤΟΣ (10 X 26) ΔΕΞΙΑ - ΑΡΙΣΤΕΡΑ

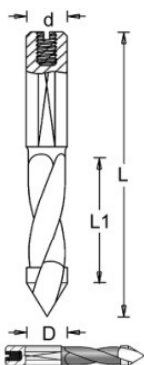

	D	L					
	4	57,5					
	5	57,5					
	6	57,5					
	7	57,5					
	8	57,5					
	10	57,5					

ΤΡΥΠΑΝΙΑ ΞΕΤΡΥΠΗΜΑΤΟΣ ΔΕΞΙΑ - ΑΡΙΣΤΕΡΑ

4034... (d = 10 X 20)

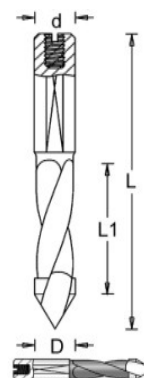

- R	- L	D	L				
019	020	4	70				
001	002	5	70				
003	004	6	70				
007	008	7	70				
009	010	8	70				
011	012	9	70				
013	014	10	70				
015	016	11	70				
017	018	12	70				

TCT DOWELL DRILLS (d=10X20) LEFT-RIGHT
ΤΡΥΠ.ΠΟΛΥΤΡΥΠ. (10X20) ΔΕΞΙ-ΑΡ
4032...

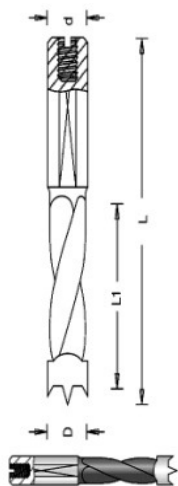

- R	- L	D	L					
001	002	4	57,5					
003	004	5	57,5					
		5,1	57,5					
		5,2	57,5					
005	006	6	57,5					
007	008	6,3	57,5					
009	010	7	57,5					
011	012	8	57,5					
		8,1	57,5					
		8,2	57,5					
013	014	9	57,5					
015	016	9,5	57,5					
017	018	10	57,5					
019	020	11	57,5					
021	022	12	57,5					
023	024	12,7	57,5					
025	026	13	57,5					
027	028	14	57,5					
029	030	15	57,5					
031	032	16	57,5					

TCT DOWELL DRILLS (d=10X20) LEFT-RIGHT
ΤΡΥΠ.ΠΟΛΥΤΡΥΠ. (10X20) ΔΕΞΙ-ΑΡ
4033... (d = 10X20)

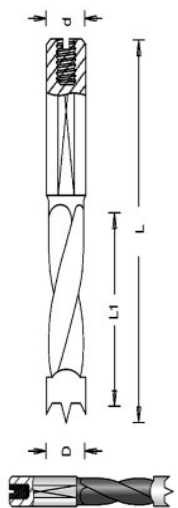

- R	- L	D	L					
001	002	4	70					
003	004	5	70					
		5,1	70					
		5,2	70					
005	006	6	70					
007	008	6,35	70					
009	010	7	70					
011	012	8	70					
		8,1	70					
		8,2	70					
013	014	9	70					
015	016	9,5	70					
017	018	10	70					
019	020	11	70					
021	022	12	70					
023	024	12,7	70					
025	026	13	70					
027	028	14	70					
029	030	15	70					
031	032	16	70					

ΤΡΥΠ. ΠΟΛΥΤΡΥΠ. - ΜΑΚΡΙΑ (x85mm)

4065... (d = 10X27)

- R	- L	D	L	L1				
001	002	5	85	58,00				
003	004	6	85	58,00				
005	006	8	85	58,00				
007	008	10	85	58,00				
009	010	12	85	58,00				
		14	85	58,00				

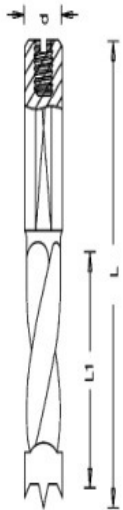

ΤΡΥΠ. ΠΟΛΥΤΡΥΠ. - ΜΑΚΡΙΑ (x105mm)

(d = 10X27)

- R	- L	D	L	L1				
		5	105	78,00				
		6	105	78,00				
		8	105	78,00				
		10	105	78,00				
		12	105	78,00				
		14	105	78,00				

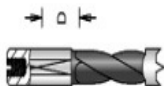

ΤΡΥΠ. ΠΟΛΥΤΡΥΠ. - ΜΑΚΡΙΑ

(d = 13X50)

- R	- L	D	L	L1				
		8	120	70,00				
		10	130	80,00				
		12	140	90,00				

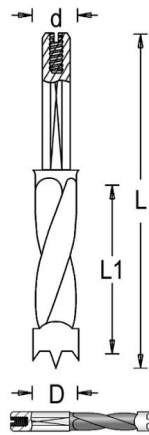

TCT DOWELL DRILLS (d=8X20)MAFELL-RIGHT

ΤΡΥΠ.ΠΟΛΥΤΡΥΠ.(8X20) MAFELL-ΔΕ

- R	- L	D	L	L1				
		5	57,5	37				
		6	57,5	37				
		8	57,5	37				
		10	57,5	37				
		12	57,5	37				
		14	57,5	37				
		16	57,5	37				

DOWEL DRILLS WITHOUT COUNTERSINK IN HM (L - R)

ΤΡΥΠ. ΠΟΛΥΤΡΥΠ. ΚΩΝΙΚΑ ΒΙΔΩΤΑ ΑΡ-ΔΕΞ (d=10) ΟΛΙΚΟ ΜΗΚΟΣ = 90mm

4013...

- R	- L	D	L					
025	026	5	50					
027	028	6	50					
029	030	8	50					
031	032	10	50					
033	034	12	50					
035	036	14	50					

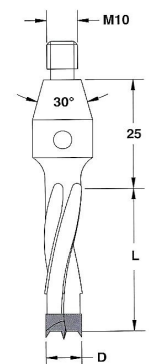

CYLINDER BORING BITS - COMBI SYSTEM (d=10X26) LEFT - RIGHT
ΤΡΥΠΑΝΙΑ ΜΕΝΤΕΣΕ ΠΟΛΥΤΡΥΠΑΝΟΥ (10 X 26) ΔΕΞΙΑ-ΑΡΙΣΤ

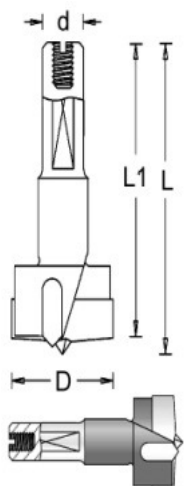

	D	L					
	15	57,5					
	16	57,5					
	18	57,5					
	20	57,5					
	22	57,5					
	24	57,5					
	25	57,5					
	26	57,5					
	28	57,5					
	30	57,5					
	35	57,5					
	40	57,5					

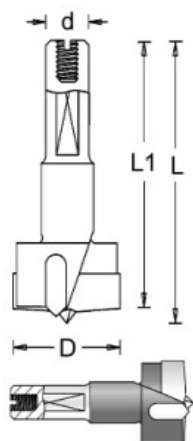

	D	L					
	15	70					
	16	70					
	18	70					
	20	70					
	22	70					
	24	70					
	25	70					
	26	70					
	28	70					
	30	70					
	35	70					
	35	90					
	38	70					
	40	70					

UDJUSTABLE CULINDER BORING BITS -

D=30-60mm L=90 d=10

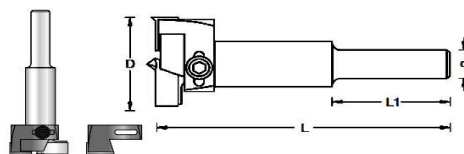

ΡΥΘΜΙΖΟΜΕΝΟ ΤΡΥΠΑΝΙ ΜΕΝΤΕΣΕ

D=50-80mm L=105 d=12,7

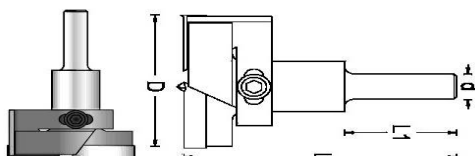

**TCT - CYLINDER BORING BITS (Z2 + 2) (d 10X 26) (L - R)
 ΜΕΝΤΕΣΕΣ ΠΟΛΥΤΡΥΠΑΝΟΥ ΜΕ ΕΝΑΛ.ΠΛΑΚΙΔΙΑ (ΞΥΡΑΦΙΑ) ΔΕΞΙ-ΑΡ
 4045...**

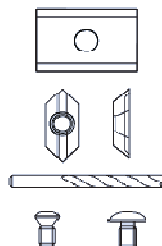

- R	- L	D	L	d				
001	002	25	57,5	10 X 26				
003	004	26	57,5	10 X 26				
005	006	30	57,5	10 X 26				
007	008	35	57,5	10 X 26				
009	010	40	57,5	10 X 26				
	051	TC BLADE D25 (10,5X12X1,5)						
	052	D26 (11X12X1,5)						
	053	D30 (13X12X1,5)						
	054	D35 (15,7X12X1,5)						
	055	D40 (18X12X1,5)						
		TC BLADE (ΠΡΟΚΟΨΗ)						
	061	(D25-26-30-35-40) (18X8X4)						
		DOWEL DRILL-						
071	072	ΤΡΥΠΑΝΙ ΚΕΝΤΡΟ						

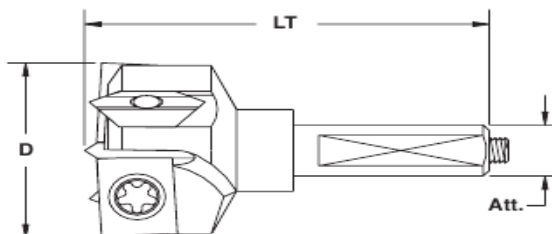

**KNOT CORRECTING TIPS FOR BORING MACHINES Z2+2 IN HM
 SHANK FOR MACHINES: MORBIDELLI, BIESSE, REIMALL, WEEKE,
 VITAP (new execution)**

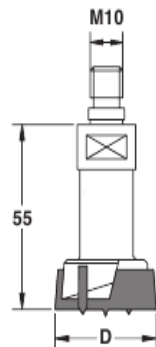

4022...

- R	- L	D						
001	002	20						
003	004	25						
005	006	26						
007	008	30						
009	010	35						
011	012	40						

**KNOT CORRECTING TIPS FOR BORING MACHINES Z2+2 IN HM
 SHANK FOR MACHINES: VITAP, OMPEC, BALESTRINI,
 BUSELLATO (old execution)**

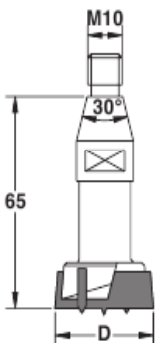

4023...

- R	- L	D						
001	002	20						
003	004	25						
005	006	26						
007	008	30						
009	010	35						
011	012	40						

COUNTERSINK FOR DOWELL DRILLS (L-R)
ΦΡΕΖΕΣ ΤΡΥΠ.ΠΟΛΥΤΡ.ΔΕΞΙΕΣ - ΑΡ+Α30
4035...

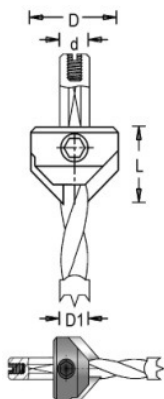

- R	- L		D				
001	002		4				
003	004		5				
005	006		6				
009	010		7				
011	012		8				
013	014		9				
017	018		10				
021	022		12				

REDUCTION BUSHING
ΚΟΛΕΤΣ ΠΟΛΥΤΡΥΠ. (d 10x25)
4043...

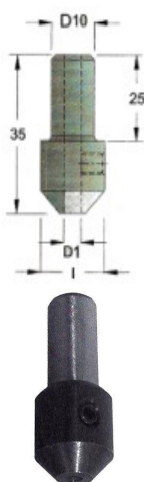

			d				
001			2				
003			2,5				
005			3				
007			3,2				
009			3,5				
011			4				
013			5				

REDUCTION BUSHING
ΚΟΛΕΤΣ ΠΟΛΥΤΡΥΠ. L=25mm
4044



	D	D1	L				
001	10	2	23				
003	10	2,5	23				
005	10	3	23				
007	10	3,2	23				
009	10	6,5	23				
011	10	4	23				
013	10	5	23				

ΤΡΥΠΑΝΙΑ ΑΝΤΙΓΡΑΦΗΣ ΓΙΑ ΠΑΝΤΟΓΡΑΦΟΥΣ

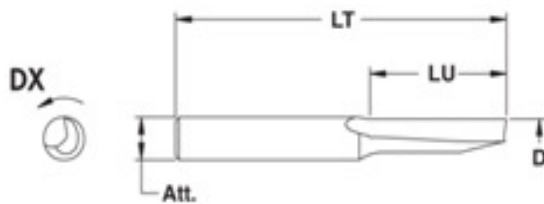

3001

- R	- L	D	LU	LT		Z	rpm	
001	002	2	10	90	11X50	1	24000	
003	004	3	14	90	11X50	1	24000	
005	006	4	17	90	11X50	1	24000	
007	008	5	22	90	11X50	1	24000	
009	010	6	26	90	11X50	1	24000	
011	012	8	32	90	11X50	1	24000	
013	014	10	37	90	11X50	1	24000	
015	016	12	40	90	11X50	1	24000	
017	018	14	40	90	11X50	1	24000	
019	020	16	40	90	11X50	1	24000	

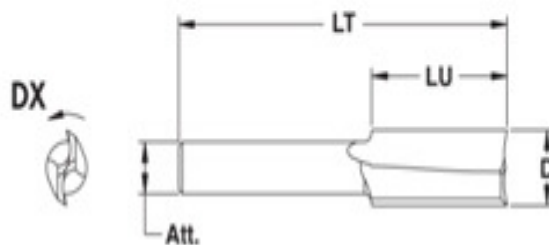

3002

- R	- L	D	LU	LT		Z	rpm	
001	002	10	37	90	11X50	2	24000	
003	004	12	40	90	11X50	2	24000	
005	006	14	40	90	11X50	2	24000	
007	008	16	40	90	11X50	2	24000	
009	010	18	40	90	11X50	2	24000	
011	012	20	40	90	11X50	2	24000	
013	014	22	40	90	11X50	2	24000	
015	016	24	40	90	11X50	2	24000	

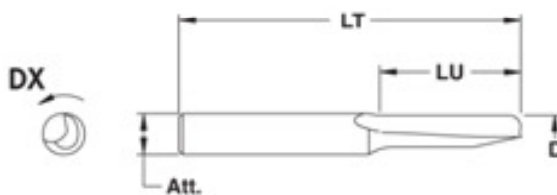

3003

- R	- L	D	LU	LT		Z	rpm	
001	002	2	10	90	11X50	1	24000	
003	004	3	14	90	11X50	1	24000	
005	006	4	17	90	11X50	1	24000	
007	008	5	22	90	11X50	1	24000	
009	010	6	26	90	11X50	1	24000	
011	012	8	32	90	11X50	1	24000	
013	014	10	37	90	11X50	1	24000	
015	016	12	40	90	11X50	1	24000	
017	018	14	40	90	11X50	1	24000	
019	020	16	40	90	11X50	1	24000	

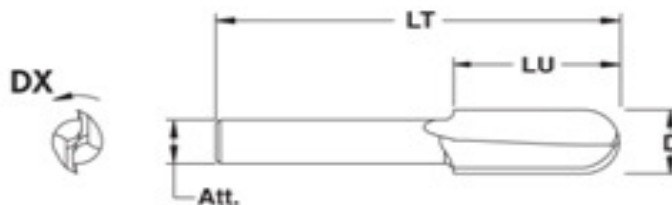

3004

- R	- L	D	LU	LT		Z	rpm	
001	002	10	37	90	11X50	2	24000	
003	004	12	40	90	11X50	2	24000	
005	006	14	40	90	11X50	2	24000	
007	008	16	40	90	11X50	2	24000	
009	010	18	40	90	11X50	2	24000	
011	012	20	40	90	11X50	2	24000	
013	014	22	40	90	11X50	2	24000	
015	016	24	40	90	11X50	2	24000	



ΤΥΠΟ

A1

A2

A3

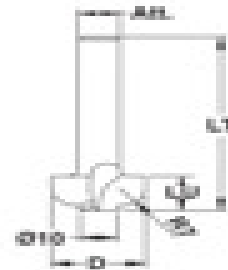
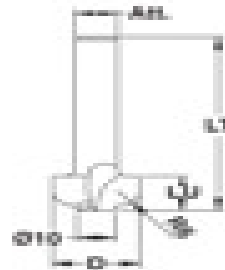
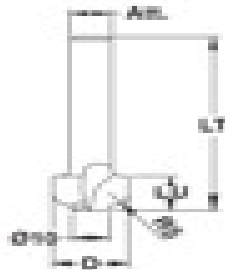

ΤΥΠΟ

B1

B2

B3

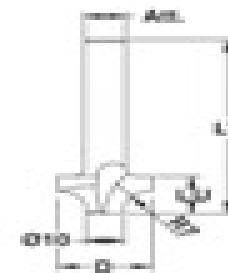
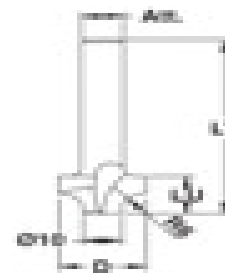
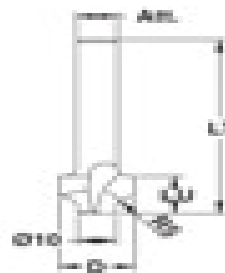

3005





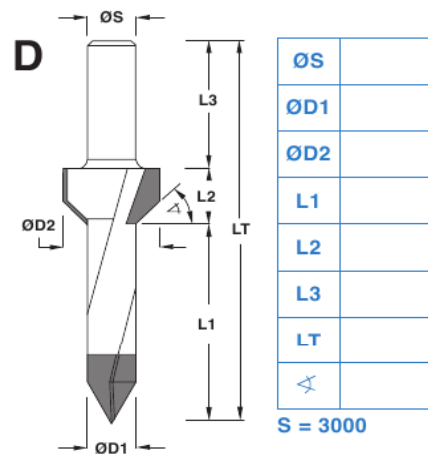
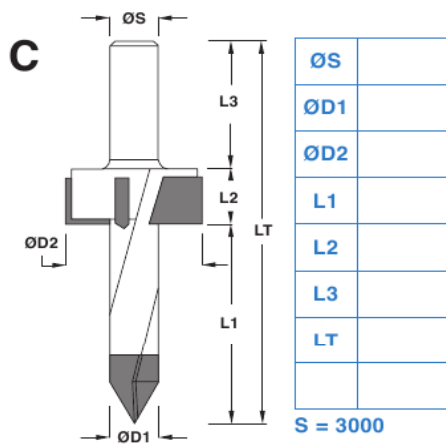
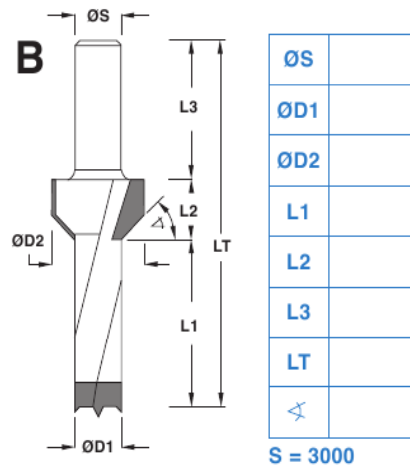
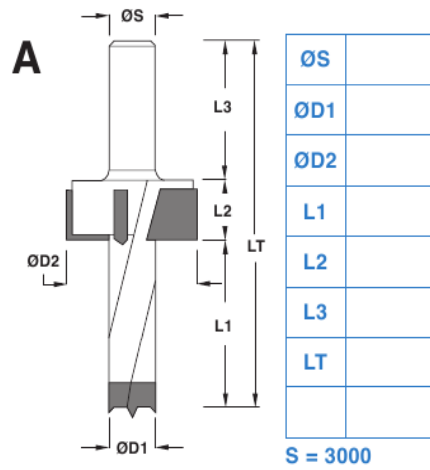

- R	- L	D	LU	LT		Z	rpm	
001	002	20	15	70-A1	11X50	2	24000	
003	004	22	15	70-A2	11X50	2	24000	
005	006	24	15	70-A3	11X50	2	24000	
007	008	20	15	70-B1	11X50	2	24000	
009	010	22	15	70-B2	11X50	2	24000	
011	012	24	15	70-B3	11X50	2	24000	

DOUBLE DIAMETER DRILLS IN HM

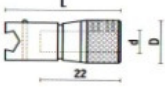
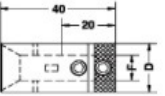
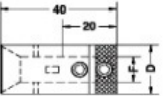
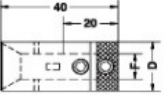
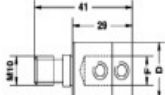
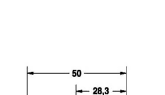
4011...

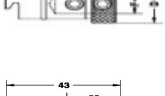

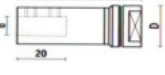
REDUCING CHUCKS FOR DOWELL DRILLS "QUICK CHANGE"
ΦΩΛΙΕΣ ΑΥΤΟΜΑΤΕΣ ΠΟΛΥΤΡΥΠΑΝΟΥ

ΚΩΔΙΚΟΣ								
	P/P - A	QUICK CHANGE BUSSELATO ΑΥΤΟΜΑΤΗ D=19 L=34,5 d=10						
	P/P - B - 12	VITAP - STETON - MESA - MAGGI MASTERWOOD-GRIGGIO ΑΥΤΟΜΑΤΗ D=18-20 L=40 d1=12 d=10						
	P/P - B - 14	VITAP - STETON - MESA - MAGGI MASTERWOOD-GRIGGIO ΑΥΤΟΜΑΤΗ D=18-20 L=40 d1=14 d=10						
	4062001 P/P-B-12-42	QUICK CHANGE VITAP-MAGGI- MESA ΑΥΤΟΜΑΤΗ D=18-20 L=42 d1=12 d=10						
	4024002 P/P - C - L	FOR MACHINES WITH SHANK (B29 L41) ON SCREW M 10-ΙΣΙΕΣ-ΑΡΙΣΤ (4026002 B25 L40)						
	4024001 P/P - C - R	FOR MACHINES WITH SHANK (B29 L41) ON SCREW M 10-ΙΣΙΕΣ-ΔΕΞΙΕΣ (4026001-B25 L40)						
	4028002 P/P - D - L	FOR MACHINES WITH SHANK (B28,3 L50) ON SCREW - CONIC M 10-ΚΩΝΙΚΕΣ - ΑΡΙΣΤΕΡΕΣ						
	4028001 P/P - D - R	FOR MACHINES WITH SHANK (B28,3 L50) ON SCREW - CONIC M 10 - ΚΩΝΙΚΕΣ - ΔΕΞΙΕΣ						
	P/P - E	QUICK CHANGE BIESSE ΑΥΤΟΜΑΤΗ D=20 L=37 d=10						
	P/P - F	QUICK CHANGE MORBIDELLI ΑΥΤΟΜΑΤΗ D=20 L=43 d=10 A=20°						
	P/P - G	QUICK CHANGE ΑΥΤΟΜΑΤΗ D=18 L=34 d=10						
	P/P - H	QUICK CHANGE WEEKE ΑΥΤΟΜΑΤΗ D=20 L=46 d=10						

ADAPTER "QUICK SHANK" FOR MACHINES WITH SHANK OR SCREW
SET OF ADAPTERS "QUICK SHANK" TO SET ON TRADITIONAL MACHINES,
IN CHANGING THE STANDARD REDUCING CHUCKS INTO THE ADAPTER,
THE LONG TIMES FOR THE CHANGE OF DRILLS, WILL DISSAPEAR.
THIS WILL INCREASE CONSIDERABLY THE PRODUCTIVITY.

4057...



FOR MACHINES: AYEN, HOLZMA

B		R	L					
22,50		001	002					

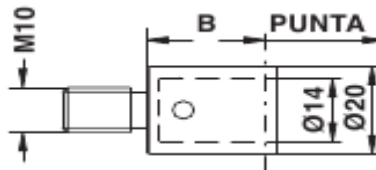

FOR MACHINES: MORBIDELLI, BIESSE, WEEKE,
BUSELLATO, TORWEGGE

B		R	L					
22,50		003	004					

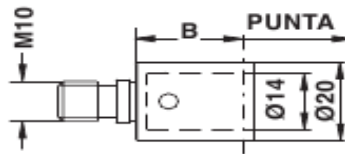

FOR MACHINES: VITAP, ALBERTI

B		R	L					
22,50		005	006					

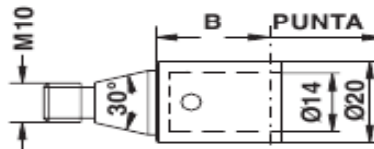

FOR MACHINES: NOTTEMEYER

B		R	L					
22,50		007	008					

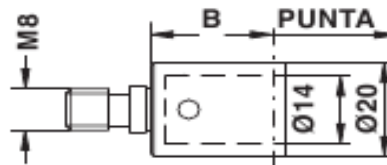

CARRYING DRILL

F	D	L						
10,00	18	17,5		011				

